

EXPLORING SPACE with NASA'S UNIVERSE of LEARNING

A SCIENCE ACTIVITY BOOK

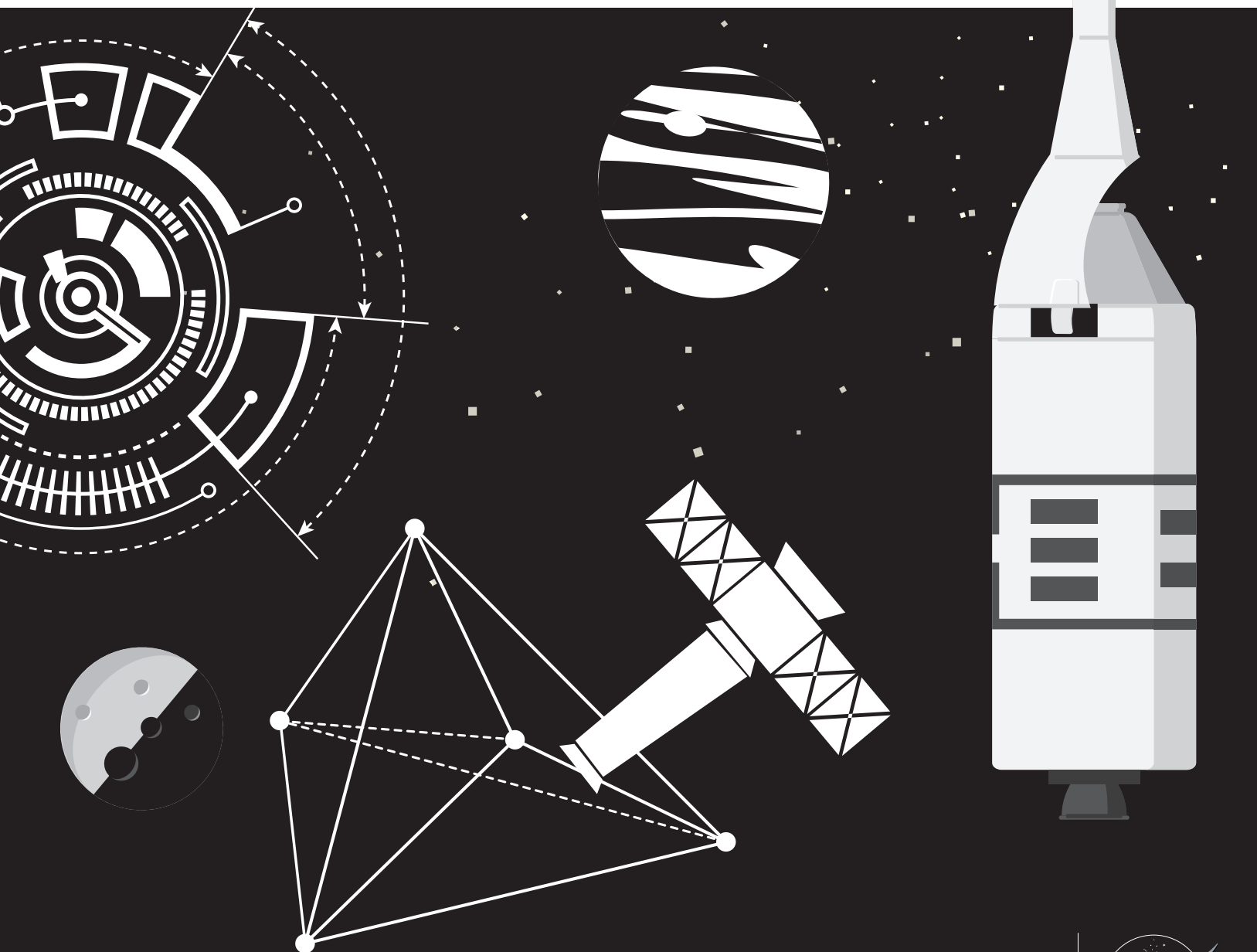

Telescopes, Light, Space and the Stars

Light takes on many forms - from radio to infrared to X-rays and more. And the Universe tells its story through all of these different types of radiation. In order to really understand the Universe, astronomers need different kinds of telescopes like NASA's James Webb Space Telescope (capturing infrared light), Chandra X-ray Observatory (X-ray light), Hubble Space Telescope (optical light as well as some infrared and ultraviolet light) and others.

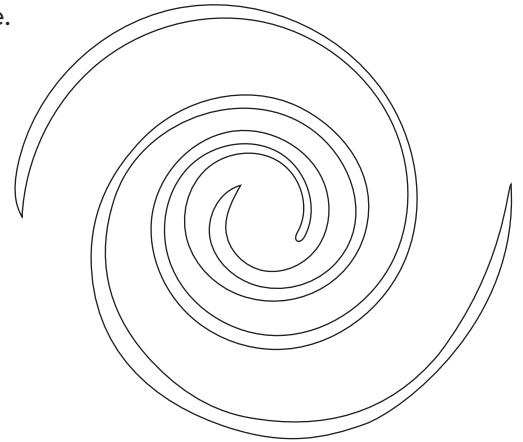

For observing in many kinds of light and in incredible detail, we often have to go up above Earth's atmosphere. This means we have to launch satellites and rockets into space, sometimes with the help of astronauts.

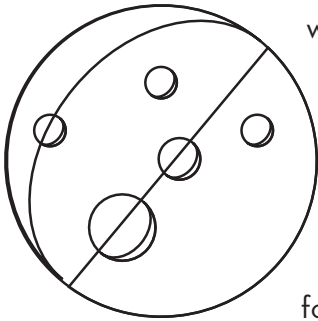

How do we make images of things in space with our space-based telescopes? When telescopes like Webb, Chandra or Hubble capture data, they don't arrive as an assembled picture. Instead, the spacecraft streams data encoded in the form of ones and zeroes, which are eventually translated into various formats, including images, that we can understand and enjoy.

This activity pad will take you on a journey into space flight (with paper airplanes) and how we talk to our telescopes in space (see binary code and binary beats). We'll meet a couple of astronauts (in coloring pages and zines), and then learn about exploded stars (through paper circuits, origami and a coloring page).

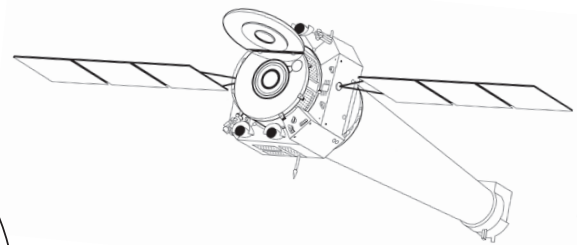
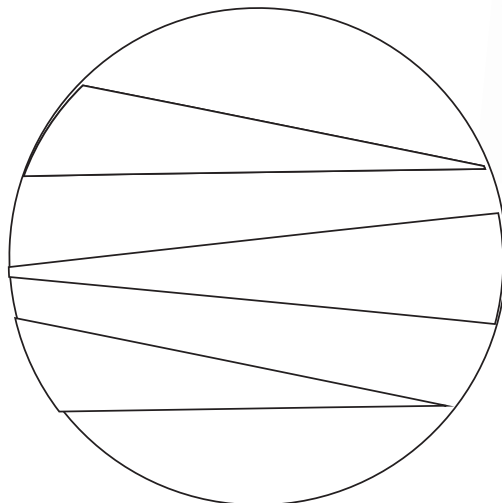
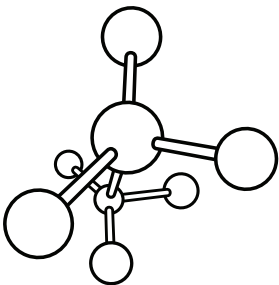
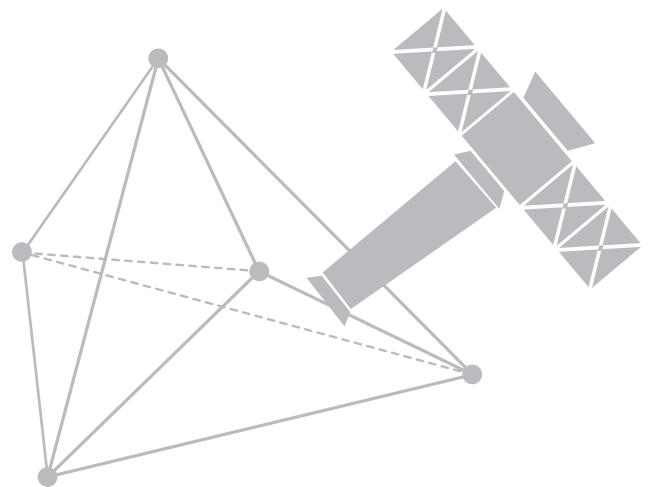
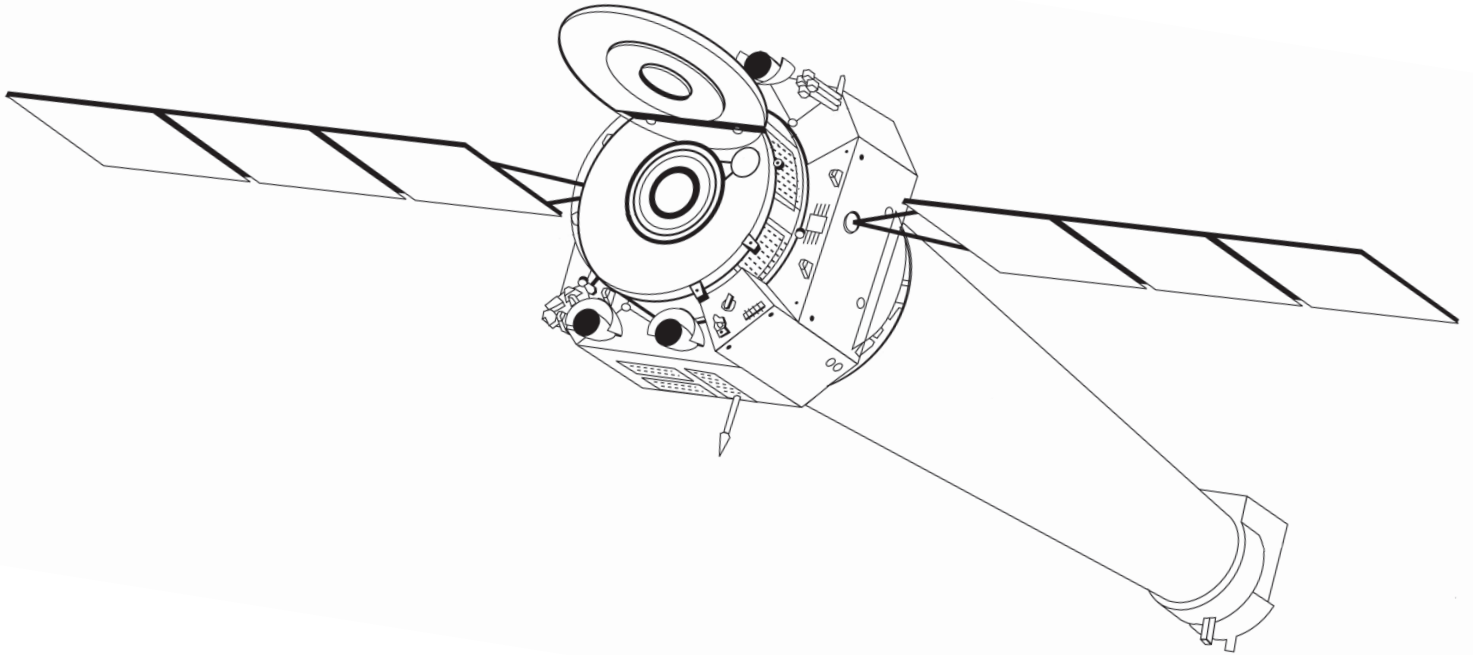

TABLE OF CONTENTS

How to Talk to a Space Craft: Binary Code	1-2
Launching into Space: Science of Flying.....	3-4
Coloring Page: Astronaut Cady Coleman	5
Coloring Page: Astronaut Mae Jemison	6
Origami a Japanese Style of Paper Folding	7-8
Coloring Page: Supernova Cassiopeia A	9
Light Up Exploded Stars	10-11
Binary Beats.....	12-13
Women in Stem Zine	14
Putting Together Your Zine.....	15





HOW TO TALK TO A SPACECRAFT: BINARY CODE

Telescopes in space, such as NASA's Chandra X-ray Observatory or Hubble Space Telescope, use binary code to send information down to Earth. Binary code is a system that uses two digits to represent things. You can think of each 1 and 0 like an "on" and "off" position of a switch. Binary code is a simple, effective way to talk to many kinds of electrical machines because with electricity, it's either on or off.

Our cell phones, computers, and other digital equipment all use a binary code made up of a 256-letter of uppercase letters, lowercase letters, numbers, etc., if they are based in the English language. The characters are each assigned an 8-character binary equivalent. The location of each "1" represents that position's value, which is used to calculate the total value of the binary number. The positions of all eight characters then equal a fixed number value. The letter A for example is written as "01000001".

Binary code can be thought of as a foreign dialect that needs to be translated into a language that you can understand. Binary code is "spoken" in those sets of ones and zeros. If you know the code, or how to translate, you (or a computer) can "read" or understand. For another way to think about binary code, please visit Binary Beats on page 12-13.

Here is a chart of alphabet characters:

A	01000001	H	01001000	O	01001111	V	01010110
B	01000010	I	01001001	P	01010000	W	01010111
C	01000011	J	01001010	Q	01010001	X	01011000
D	01000100	K	01001011	R	01010010	Y	01011001
E	01000101	L	01001100	S	01010011	Z	01011010
F	01000110	M	01001101	T	01010100		
G	01000111	N	01001110	U	01010101		

Use the chart above to write your name in code.



Can you tell what is written here below?

01000011 | 01001000 | 01000001 | 01001110
01000100 | 01010010 | 01000001

LAUNCHING INTO SPACE: THE SCIENCE OF FLYING

Some paper planes fly better than others. Why is that? One important factor is design. Other factors include the type of paper, how hard you push it and at what angle, and even the weather (if you're outside).

What are the forces that enable a plane to fly? Force is something that pushes or pulls on something else. When you throw a paper plane in the air, you are giving the plane a push to move forward. That push is a type of force called thrust. While the plane is flying forward, air moving over and under the wings is providing an upward lift force on the plane. At the same time, air pushing back against the plane is slowing it down, creating a drag force. The weight of the paper plane also affects its flight, as gravity pulls it down toward Earth. All of these forces (thrust, lift, drag and gravity) affect how well a given paper plane's flight will go.

MAKE A PAPER AIRPLANE

Create a "starting line" on the floor with tape, or by noting the tile square or other marker on the floor. Place your toe on the floor line and throw the paper plane. Did it fly very far?

Throw the plane at 3 or 4 more times. Each time before you throw the plane, make sure it is still in good condition (that the folds and points are still sharp). When you toss it, place your toe on the line and try to launch the plane with a similar amount of force, including gripping it at the same spot. Did it go about the same distance each time?

Make a new paper plane or even two planes that are different sizes and compare how well they fly. Do bigger planes fly farther?

Try making paper planes out of different types of paper, such as printer paper, construction paper and newspaper. Use the same design for each. Does one type of paper seem to work best for making paper planes? Does one type work the worst?

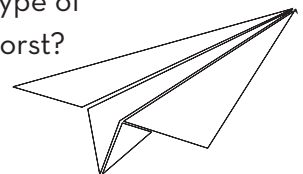
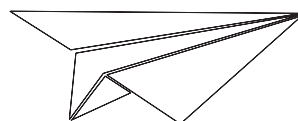
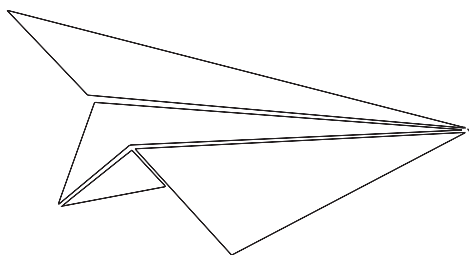

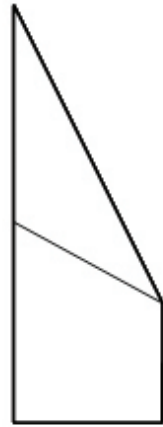
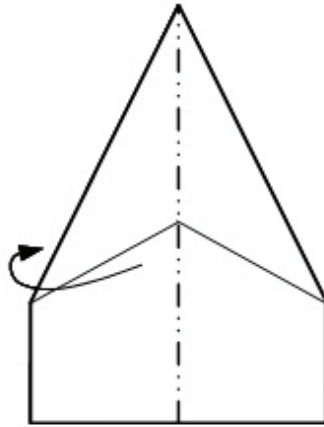
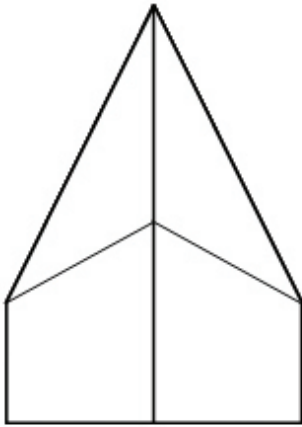
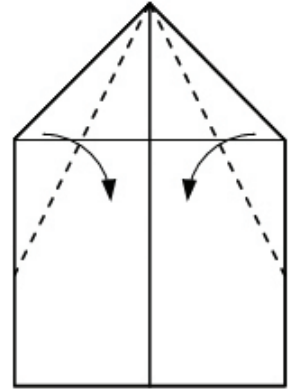
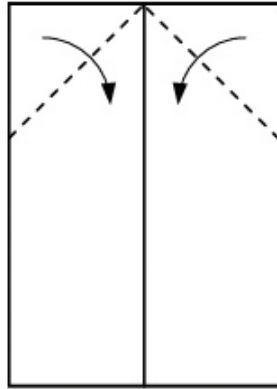
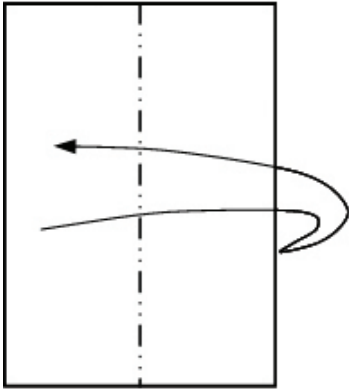

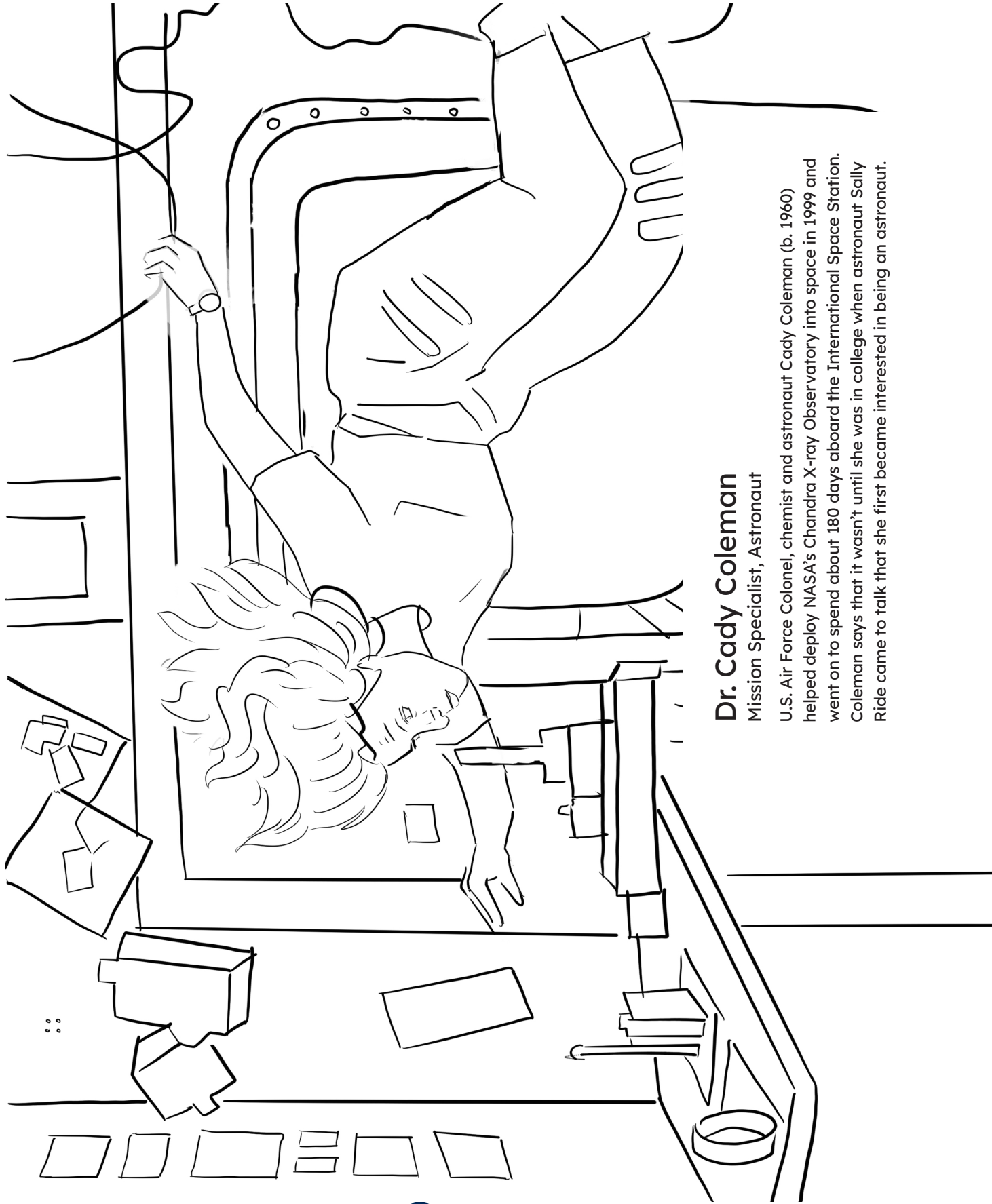

Dr. Cady Coleman

Mission Specialist, Astronaut

U.S. Air Force Colonel, chemist and astronaut Cady Coleman (b. 1960) helped deploy NASA's Chandra X-ray Observatory into space in 1999 and went on to spend about 180 days aboard the International Space Station. Coleman says that it wasn't until she was in college when astronaut Sally Ride came to talk that she first became interested in being an astronaut.

Dr. Mae Jemison

Engineer, Physician & NASA Astronaut

Dr. Jemison was the NASA science mission specialist on the eight-day joint mission with Japan's space agency, which included 24 materials science and 20 life sciences experiments. She was the first African-American woman to fly in space.

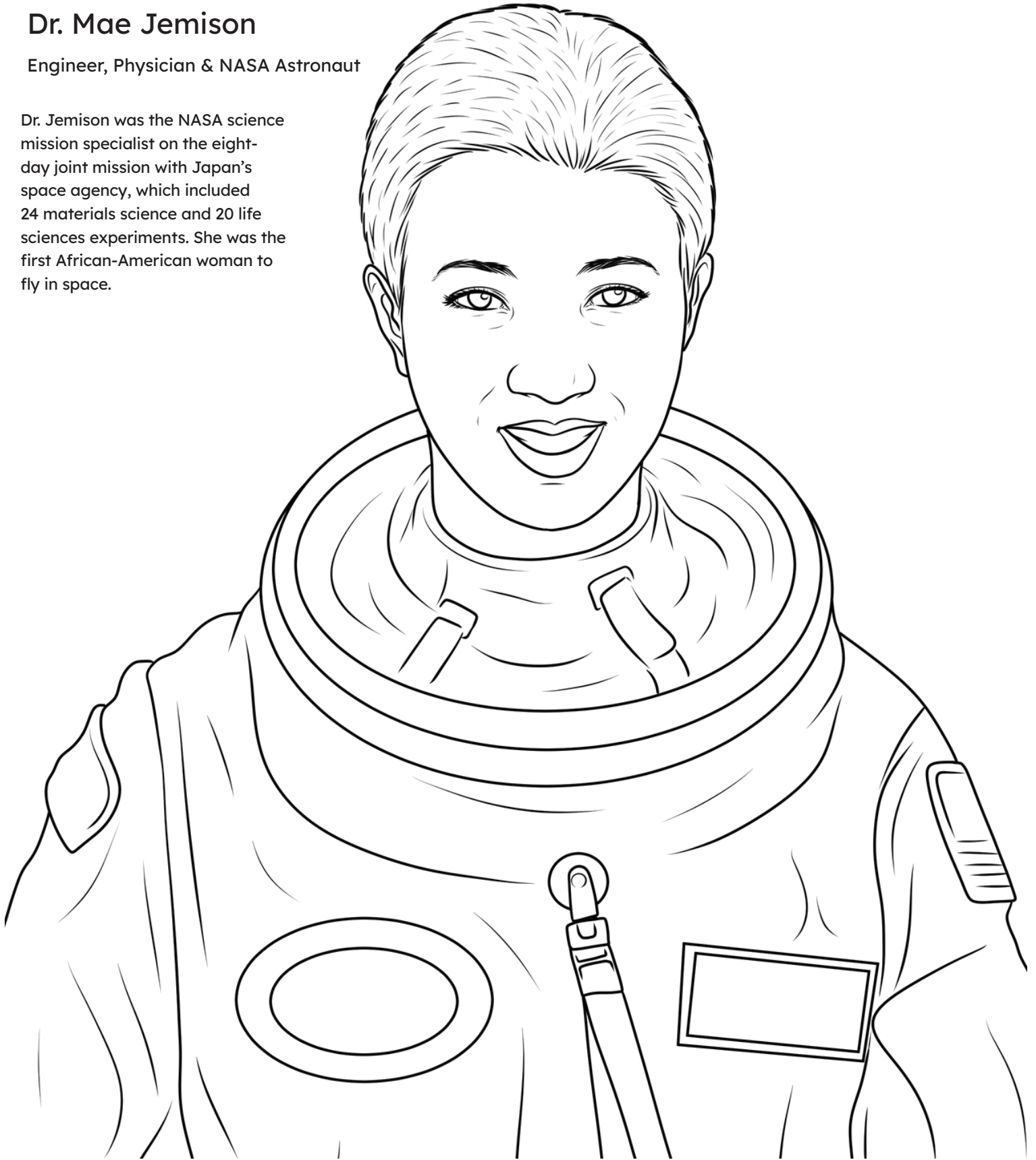

YOUR ORIGAMI UNIVERSE

Not only is it a decorative art form, origami provides solutions to many problems in modern science and engineering. For example, origami-inspired techniques are used to unfold stents in clogged arteries, release airbags during automobile collisions, and even unfurl the large mirror for the James Webb Space Telescope.

In astrophysics, there are instances where the expansion and unpacking of origami demonstrates what scientists witness. Take the death of stars. When a star about 10 to 15 times more massive than our Sun runs out of nuclear fuel, it will collapse onto itself and then create a giant explosion. This energetic event, known as a supernova, hurls the outer layers of the star into space, creating an elegant tapestry of energy and stellar debris. NASA's Chandra X-ray Observatory and other telescopes have looked at many of these explosions and the debris fields they leave behind

Use a long narrow strip of paper to create your star like the strip on the right.

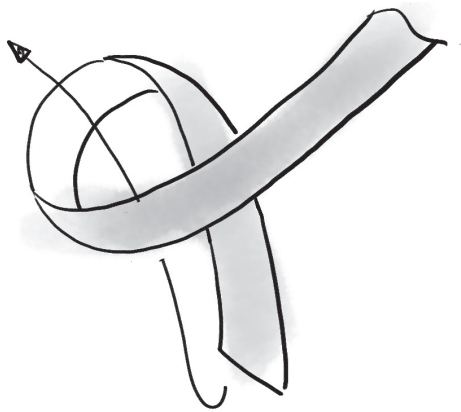

- 1** Make a loop at one end of the paper. Weave the short end of the paper through the loop.

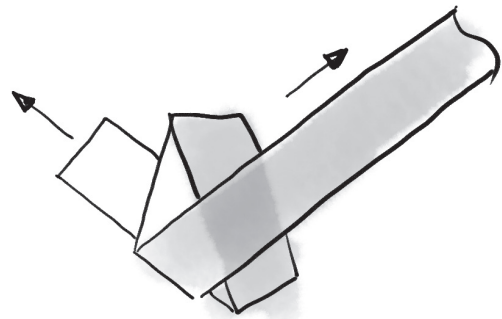

- 2** Tighten knot and press flat.

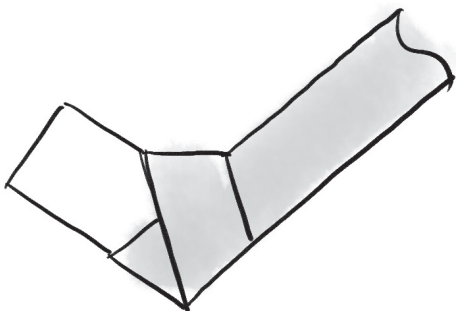

- 3** Fold short-end of paper down towards center of star. If it is too long, tear off a small piece.

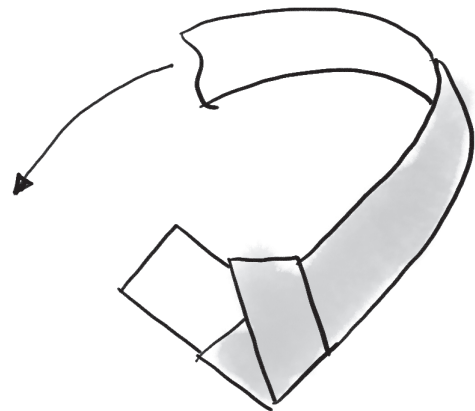

- 4** Fold long-end of paper up. Make sure edges line up right on top of one another.

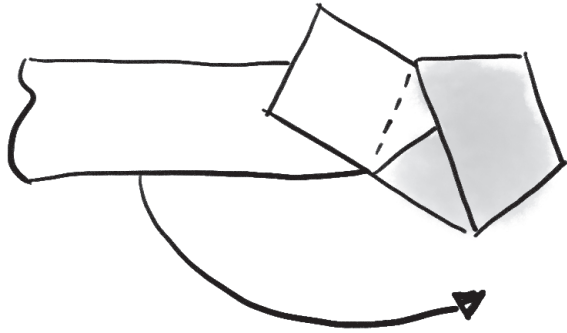

5 Flip paper around so long-end of paper is pointing down again.

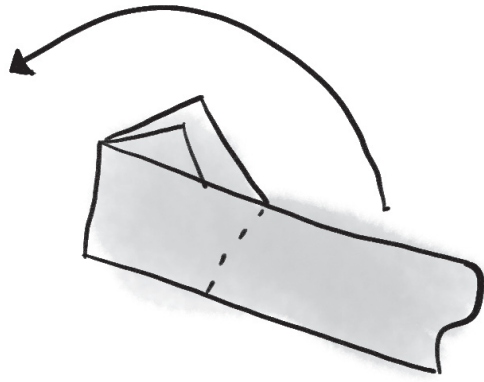

6 Fold long-end of paper up and to the left. Make sure edges line up one on top of the other.

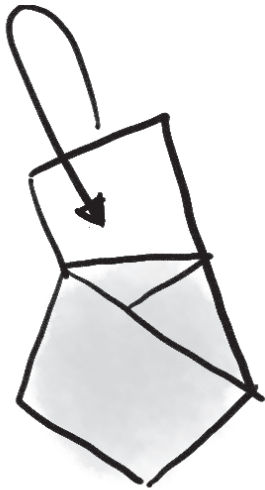

7 Flip paper around again so long-end of paper is pointing down.

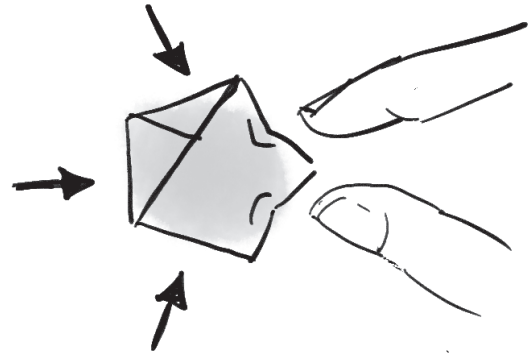

8 Pinch the sides and puff out your star! Be careful here, too, to avoid ripping your star.



Scan to learn more:



SUPERNOVA CASSIOPEIA A

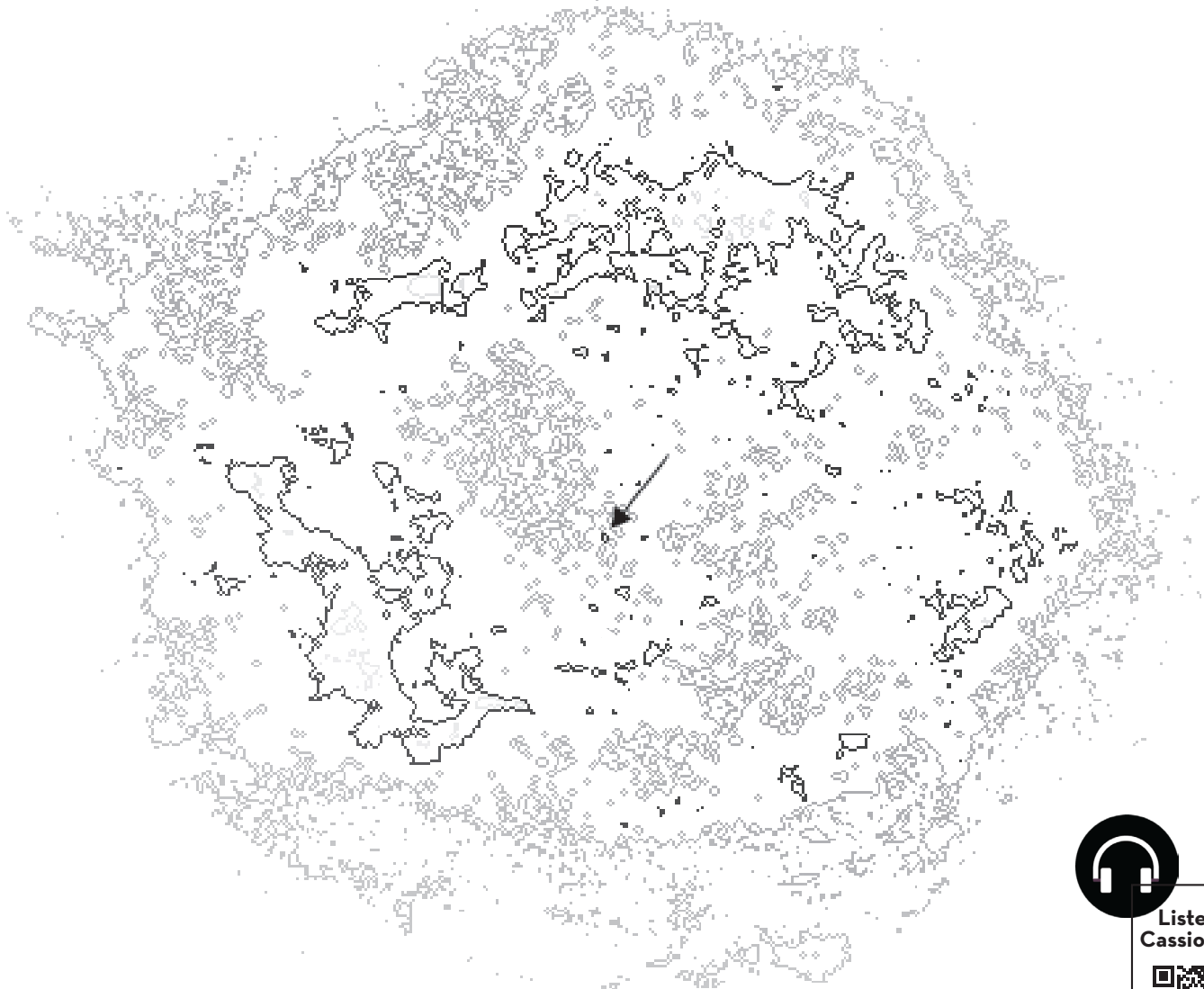

Listen to
Cassiopeia a



Cassiopeia A (Cas A) was a massive star that used up all of its fuel and exploded. The scattered, glowing remains from the explosion are called a supernova remnant. Cas A's explosion produced a cloud of very hot (50 million degree) gas that is still expanding. Chandra's sharp focus allowed scientists to identify a dot in the center (see arrow) that is the hot, superdense neutron star formed as a result of the star's collapse and explosion.

LIGHT UP EXPLODED STARS

This hands-on activity uses printable templates to create simple paper circuits. It can be good for MakerFaires, libraries, classrooms, and other STEM-related events.

What is a Paper Circuit?

Paper circuits help learners of all ages explore the basics of electricity (energy that results from the existence of charged particles like electrons or protons) and conductivity (the degree to which a material can conduct electricity). Paper circuits function as simple low-voltage electronic circuits (a path through which electrons from a voltage or current source flow) made using paper, LED lights, a type of conductive tape such as copper, as well as a small battery for the power source.

Directions: Download the attached .pdf and print double-sided (so the shapes are lined up) and cut in half (you will get two handouts per page)

1. Have participants cut out the rectangle - see handout for instructions
2. Ask participants to fold paper in half on the dashed line so that the directions are on the INSIDE/images are on the OUTSIDE.
3. Punch a hole for the LED light - see template
4. Following the remaining steps outlined on the handout - placing copper tape, finding the positive lead on the LED and affixing the leads to the circuit, and folding over with the coin battery.
5. Use a binder clip to hold battery in place on the circuit (so the light stays on)

Troubleshooting

- Flip the battery over. If the LED was put in backwards, it just means the positive and negative parts of the circuit are reversed
- Check all connections - around the LED leads, alignment with the battery, any broken places in the copper tape. Use more tape to reinforce connection.

Cost: About \$0.50 (50 cents) per item, estimates are provided in the materials list

Time: about 5 minutes to make a single item

Materials:

- Coin Batteries (\$0.30 each)
- Copper tape with conductive adhesive (\$0.10) - Less than 12 inches per badge
- LED's (\$0.05)
- Small binder clips (\$0.05)
- NASA Images of exploding stars/pulsars/neutron stars (download template here: chandra.si.edu/make/template.pdf)
- Hand held hole punchers
- Small trash can – little bits of trash are produced during the activity



LIGHT UP EXPLODED STARS

Paper Circuits #1 Template

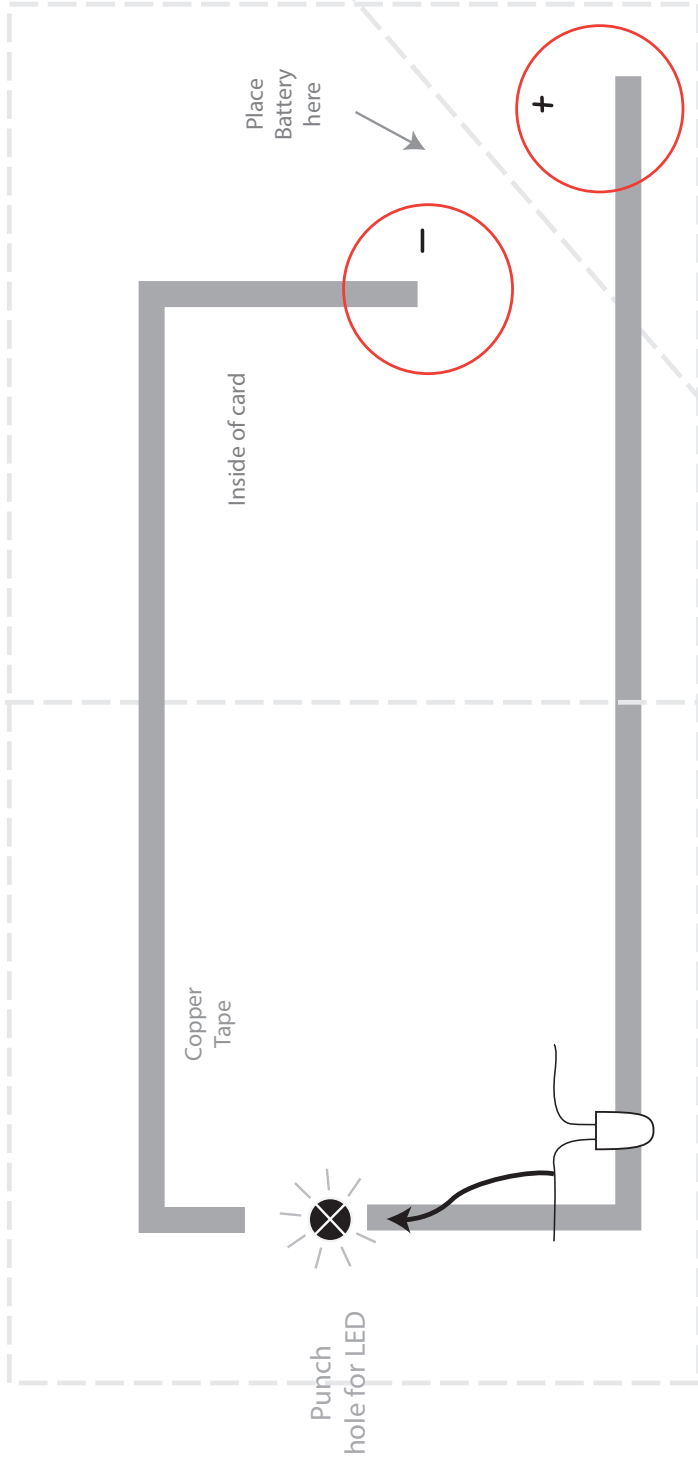
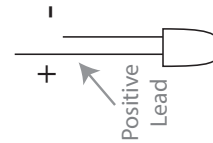

Image on opposite side here

1. Place copper tape along the gray lines
Note: Apply the foil as a continuous piece rather than separate pieces, even when turning corners.
2. Find positive lead on LED. (it's longer)
3. Bend leads and place LED through punched hole with positive lead to the left



4. Connect the LED leads to the circuit using clear tape.
5. Fold the page corner along dotted line and place the battery "+" side-up over the "-" circle.
6. Fold the corner flap over, and clip the battery in place with a binder clip. Light should turn on.



Scan to learn more:



BINARY BEATS

When we count, multiply, divide or do other types of mathematical calculations, we use these ten digits- 0, 1, 2, 3, 4, 5, 6, 7, 8 and 9. When writing words, sentences or other types of written communication we use letters like A, B, C, D, E, F, G and so on. However, computers use an alternate system of representations called “binary code” to communicate all sorts of information. By using a pattern of 0’s and 1’s over eight spaces or bits, binary code can be used to represent other letters, numbers or symbols that can be used to communicate with other computers or different forms of modern technologies.

Here is the letter A, capital A, shown in binary code form: 01000001. Notice where the 1 digits fall within the 8 digit sequence. The 1’s are in the second and eighth position in the binary code sequence. Wonder what the letter A in binary code would sound like? If we perform the 0’s as a silence or rest, and the 1’s as a drum sound, it would sound like this!

LETTER A

0	1	0	0	0	0	0	1
	drum						drum

Let’s do that again.

0	1	0	0	0	0	0	1
	drum						drum



Let’s add a steady pulse that will play quietly in the background. Here is the sound of the pulse.

1	2	3	4	5	6	7	8
---	---	---	---	---	---	---	---

Put them together and the letter A in binary code repeated two times sounds like this.

0	1	0	0	0	0	0	1
pulse	drum	pulse	pulse	pulse	pulse	pulse	drum

0	1	0	0	0	0	0	1
pulse	drum	pulse	pulse	pulse	pulse	pulse	drum

LETTER A

Now it's your turn. Let's use our left hand to quietly keep that steady pulse. We will count you in by saying, "1, 2, ready, and."

1	2	3	4	5	6	7	8
pulse	pulse	pulse	pulse	pulse	pulse	pulse	pulse

Our right hand will perform the binary code rhythm. Let's perform the letter A sequence twice.

○	1	○	○	○	○	○	1
	drum						drum

○	1	○	○	○	○	○	1
	drum						drum

Ready to put your two hands together? The left hand keeps the pulse while the right hand performs the binary code rhythm.

For younger students, perform just the right hand binary code rhythm.

○	○	○	○	○	○	○	○	○	○	○	○	○	○
LH	LH	LH	LH	LH	LH	LH	LH	LH	LH	LH	LH	LH	LH
1								1					
RH								RH					

WOMEN IN STEM ZINE

Katherine Coleman Goble Johnson (b. 1918) is an African-American space scientist and mathematician who calculated space flight trajectories for critical NASA projects such as the 1969 Apollo 11 trip to the Moon. Johnson was known for her mathematical accuracy and was asked to double check the computer-based calculations on major space flight missions.



U.S. Air Force Colonel, chemist and astronaut **Cady Coleman** (b. 1960) helped deploy NASA's Chandra X-ray Observatory into space in 1999 and has since spent about 180 days aboard the International Space Station.



Melba Roy Mouton (b. 1929) was a mathematician and computer programmer in NASA's Trajectory and Geodynamics Division, acting as the Assistant Chief of Research Programmes. Mouton worked at NASA's Goddard Space Flight Center, coding computer programs to calculate the trajectories and locations of various aircraft.



Hypatia (born in 350) was known as a great thinker in her age. She was one of the earliest women to be a noted astronomer, mathematician and philosopher in ancient Greece and Egypt, and was also the head of an important school in Alexandria.



Inspiring WOMEN IN STEM

The history of women's contributions to the fields of science, technology, engineering, & math (STEM) is long and varied, but it has often been underrepresented. This zine highlights a few of the women who have had a crucial impact on STEM fields. Today, women are in every STEM discipline, in every type of job, and represent the widest range of background and experiences.

“It wasn’t until I went to college and Sally Ride came to talk—it just opened up that possibility of if she could do it then I could aspire to do it too.”

Cady Coleman
chemist, retired United States Air Force officer, and NASA astronaut

Learn more about these women and others at chandra.si.edu/women
www.nasa.gov

Illustrations: Kristin DiVona



Mary Jackson (b. 1921) grew up in Virginia and graduated college with a Bachelor's degree in math and physics. After spending part of her early career as a teacher, she changed paths to become a "computer" (or mathematician) for the National Advisory Committee for Aeronautics (NACA), which later became NASA. Jackson worked on data from wind tunnel experiments as well as data from aircraft and aeronautics experiments.



When **Eileen Collins** (b.1956) joined the Air Force Reserve Office Training Corp, women were not allowed to be pilots. This changed in 1976 while she was working on her undergraduate degree in math and economics. After spending over a decade in the Air Force, Collins was selected to the astronaut corps in 1990. She became the first female pilot of NASA's Space Shuttle in 1993 and the first female commander of a NASA space mission

PUTTING TOGETHER YOUR ZINE

1. Print the previous page.

2. Crease the sheet along the two main directions (by folding it in half then opening it, once for each direction).

3. Now make another pair of creases, dividing the long direction into quarters

4. Then unfold again, fold in half, and make a cut with scissors as shown - you should be cutting through two thicknesses of paper, but only as far as those quarter-folds you just made.

5. Open it out again. The resulting page should have a cut in its center.

6. Fold it in half along the long direction, so that all your pages are still on the outside

7. Now push it inwards from each end, so that the inner bit pushes out in both directions to make a kind of cross-shape.

8. Fold the resulting pages together so that your front page is outmost.

And there you have it, a little zine of 8 pages that needs no stapling or gluing!

